

32-bit Low Profile Bridges

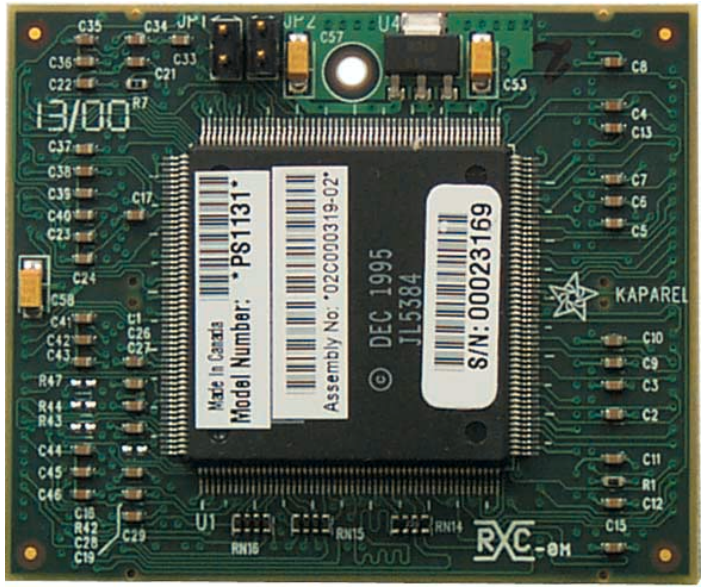
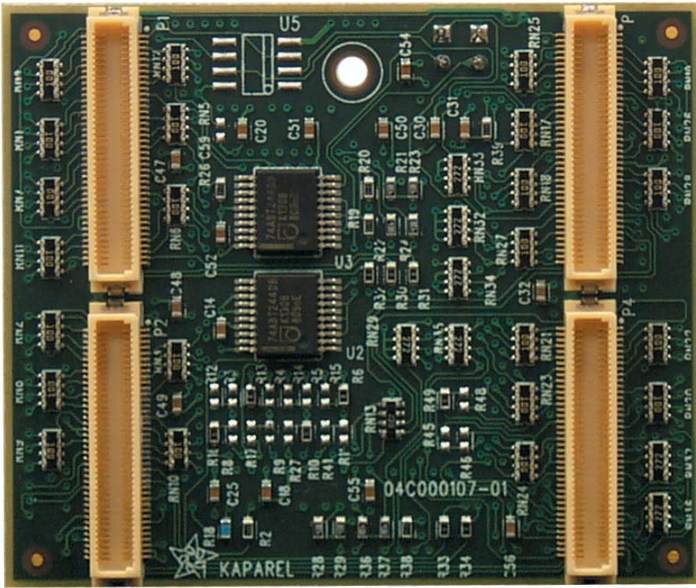

General Description:

The PS1131 and PS1133 bridge modules are low profile pallet bridges. This allows the bridge to be mounted on the rear of the backplanes, so that the maximum number of slots is available on the front of the backplane. Also, its profile space of <16 mm (see below) to the highest component enables the use of off-the-shelf rear transition modules. The PS1131 and PS1133 are 32-bit PCI to PCI bridges, using the Intel 21150 bridge chip. The PS1131 bridges from left to right, while the PS1133 bridges from right to left.

Features:

- Bridges two CompactPCI segments
- Uses Intel 21150 PCI-PCI bridge chip
- 32-bit operation
- Back bridge, no front space required
- Low profile: PS1131 and PS1133 < .395" (10 mm) thick
- Left or right bus direction supported
- Selectable IDSEL source
- Compatible with modular series backplanes

Mechanical:

The PS1131 bridge module routes the primary PCI to secondary PCI bus from left to right when looking at a front view of the cPCI backplane, while the PS1133 bridges from right to left. The bridge module is keyed such that the module cannot be inserted incorrectly. The bridge module PCB measures approximately 2" x 4" x 0.39" thick. The modules are mated parallel to the main cPCI backplane from the rear using AMP or Molex surface mount connectors. This parallel mating makes the J1 connector inaccessible for rear mated transition boards on all slots under the bridge. The bridge modules are not hot swappable. An Intel 21150 32-bit PCI to 32-bit PCI bridge IC performs the bridging function on this board.

Power:

The maximum power consumption of this bridge module is 0.5W @ 5 V and 1 W @ 3.3 V. Note that these are worst case figures. Power consumption under normal circumstances will be significantly less. Ground is connected from the primary PCI bus to the secondary PCI bus. The power supplies (+5 V, +3.3 V, +/-12 V) are not connected

across the bridge. The power supplies are AC coupled from primary to secondary to preserve signal integrity. All circuitry on the bridge module derives its power from the primary or secondary cPCI bus. The only exception to this is V(I/O) from the secondary cPCI bus, which is directly connected to the bridge IC for sensing purposes and used by pull-up resistors on the secondary bus.

Different bridge versions are available to accept V(I/O) of either +3.3 V or +5 V. The maximum power consumption of this bridge module is 0.5W @ 5 V and 1 W @ 3.3 V. Note that these are worst case figures. Power consumption under normal circumstances will be significantly less.

Ground is connected from the primary PCI bus to the secondary PCI bus. The power supplies (+5 V, +3.3 V, +/-12 V) are not connected across the bridge. The power supplies are AC coupled from primary to secondary to preserve signal integrity. All circuitry on the bridge module derives its power from the primary or secondary cPCI bus. The only exception to this is V(I/O) from the secondary cPCI bus, which is directly connected to the bridge IC for sensing purposes and used by pull-up resistors on the secondary bus.

Different bridge versions are available to accept V(I/O) of either +3.3 V or +5 V. Please contact cpcci@kaparel.com for details.

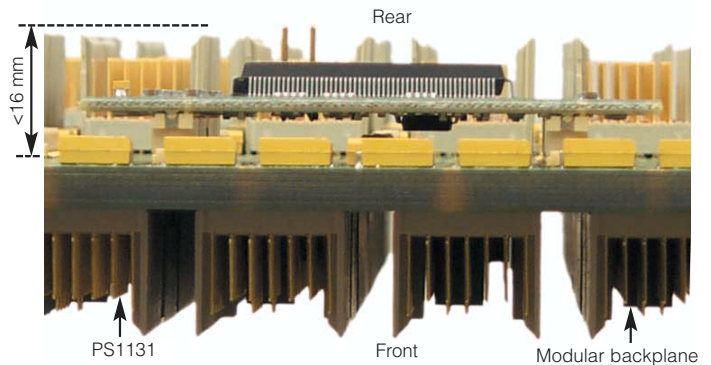

Electrical

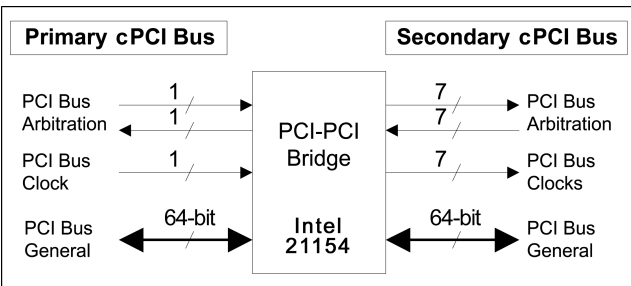

Order No.	Model No.	Description
3689210	PS1131	Left-right 32-bit low profile CompactPCI rear bridge
9810637	PS1133	Right-left 32-bit low profile CompactPCI rear bridge
Order No.	Model No.	Related parts
3686546	PS1300	3U modular series backplanes (see pg 72)
3686549	PS1400	6U modular series backplanes (see pg 73)

64-bit Low Profile Bridges

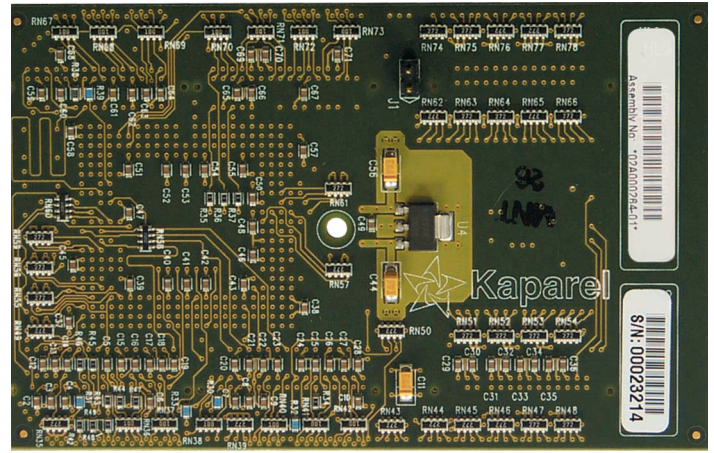
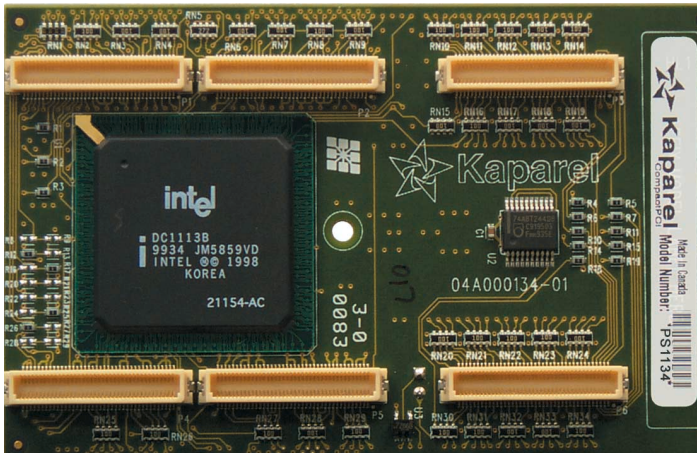

General Description:

The PS1132 and PS1134 bridge modules are low profile pallet bridges. This allows the bridge to be mounted on the rear of the backplanes, so that the maximum number of slots is available on the front of the backplane. Also, its profile space of <16 mm (see page 28) to the highest component enables the use of off-the-shelf rear transition modules. The PS1132 and PS1134 are 32-bit PCI to PCI bridges, using the Intel 21154 bridge chip. The PS1132 bridges from left to right, while the PS1134 bridges from right to left.

Features:

- Bridges two CompactPCI segments
- Uses Intel 21154 PCI-PCI bridge chip
- 64-bit operation
- Back bridge, no front space required
- Low profile: PS1132 and PS1134 < .395" (10mm) thick
- Left or right bus direction supported
- Selectable IDSEL source
- Compatible with modular series backplanes

Power:

The maximum power consumption of this bridge module is 0.5W @ 5 V and 1 W @ 3.3 V. Note that these are worst case figures. Power consumption under normal circumstances will be significantly less.

Ground is connected from the primary PCI bus to the secondary PCI bus. The power supplies (+5 V, +3.3 V, +/-12 V) are not connected across the bridge. The power supplies are AC coupled from primary to secondary to preserve signal integrity. All circuitry on the bridge module derives its power from the primary or secondary cPCI bus. The only exception to this is V(I/O) from the secondary cPCI bus, which is directly connected to the bridge IC for sensing purposes and used by pull-up

resistors on the secondary bus. Different bridge versions are available to accept V(I/O) of either +3.3 V or +5 V. Please contact cpcci@kaparell.com for details.

Mechanical:

The PS1132 bridge module routes the primary PCI to secondary PCI bus from left to right when looking at a front view of the cPCI backplane, while the PS1134 bridges from right to left. The bridge module is keyed such that the module cannot be inserted incorrectly. The bridge module PCB measures approximately 2" x 4" x 0.39" thick.

The modules are mated parallel to the main cPCI backplane from the rear using AMP or Molex surface mount connectors. This parallel mating makes the J1 connector inaccessible for rear mated transition boards on all slots under the bridge. The bridge modules are not hot swappable. An Intel 21154 64-bit PCI to 64-bit PCI bridge IC performs the bridging function on this board.

Specifications:

- PICMG 2.0 Rev 2.20 CompactPCI
 - PCI Bridge Specification Rev 1.0
- Related Products see PS1131 and PS1133 (previous page).

Electrical

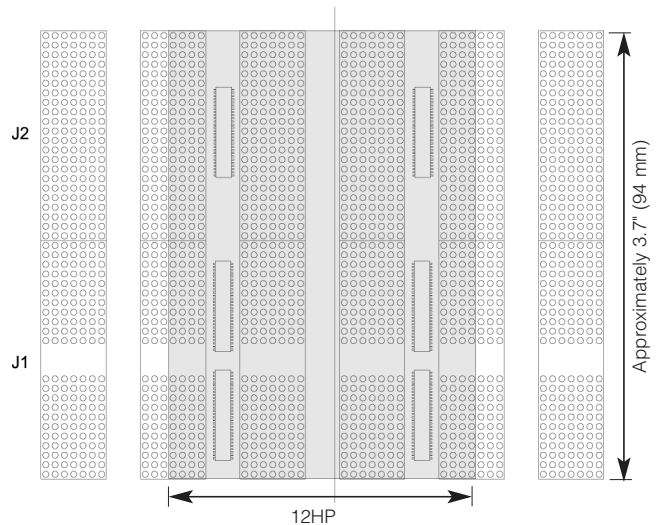
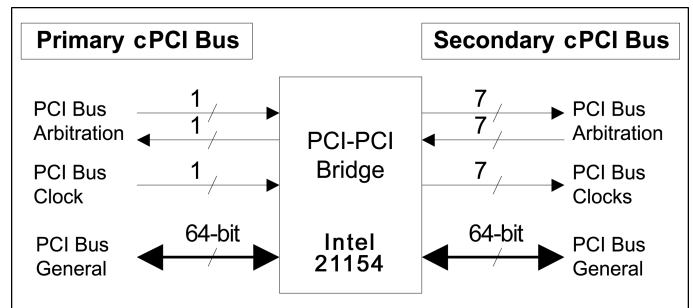

Order No.	Model No.	Description
9810637	PS1132	Left-right 64-bit low profile CompactPCI rear bridge
9812625	PS1134	Right-left 64-bit low profile CompactPCI rear bridge